

# LZ2353B/ LZ2354BJ

1/3-type CCD Area Sensors  
with 410 k Pixels

## DESCRIPTION

The LZ2353B/LZ2354BJ are 1/3-type (6.0 mm) solid-state image sensors that consist of PN photo-diodes and CCDs (charge-coupled devices). With approximately 410 000 pixels (811 horizontal x 507 vertical), the sensor provides a stable high-resolution color (LZ2353B)/B/W (LZ2354BJ) image.

## FEATURES

- Number of effective pixels : 768 (H) x 494 (V)
- Number of optical black pixels
  - Horizontal : 3 front and 40 rear
  - Vertical : 11 front and 2 rear
- Pixel pitch : 6.4  $\mu\text{m}$  (H) x 7.5  $\mu\text{m}$  (V)
- Mg, G, Cy, and Ye complementary color filters (For LZ2353B)
- Low fixed-pattern noise and lag
- No burn-in and no image distortion
- Blooming suppression structure
- Built-in output amplifier
- Variable electronic shutter (1/60 to 1/10 000 s)
- Compatible with NTSC standard (LZ2353B)/EIA standard (LZ2354BJ)
- Package :
  - 16-pin half-pitch WDIP [Ceramic]
  - (WDIP016-N-0450)
  - Row space : 11.43 mm

## PIN CONNECTIONS

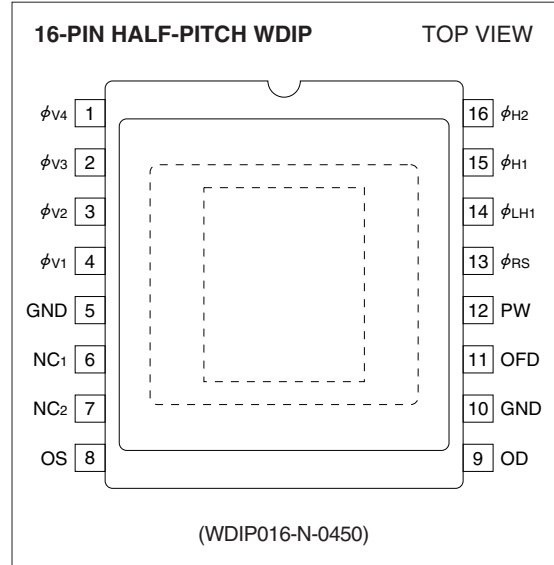

## PRECAUTIONS

- The exit pupil position of lens should be more than 25 mm (LZ2353B)/20 mm (LZ2354BJ) from the top surface of the CCD.
- Refer to "**PRECAUTIONS FOR CCD AREA SENSORS**" for details.

## COMPARISON TABLE

	LZ2353B	LZ2354BJ
TV standard	NTSC standard (Color)	EIA standard (B/W)
Characteristics	Refer to each following specification.	

**PIN DESCRIPTION**

SYMBOL	PIN NAME
OD	Output transistor drain
OS	Output signals
$\phi$ RS	Reset transistor clock
$\phi$ V1, $\phi$ V2, $\phi$ V3, $\phi$ V4	Vertical shift register clock
$\phi$ H1, $\phi$ H2	Horizontal shift register clock
$\phi$ LH1	Horizontal shift register final stage clock
OFD	Overflow drain
PW	P-well
GND	Ground
NC1, NC2	No connection

**ABSOLUTE MAXIMUM RATINGS**

(TA = +25 °C)

PARAMETER	SYMBOL	RATING	UNIT	NOTE
Output transistor drain voltage	VOD	0 to +18	V	
Overflow drain voltage	VOFD	0 to +55	V	
Reset gate clock voltage	V $\phi$ RS	-0.3 to +18	V	
Vertical shift register clock voltage	V $\phi$ V	VPW to +18	V	
Horizontal shift register clock voltage	V $\phi$ H	-0.3 to +18	V	
Horizontal shift register final stage clock voltage	V $\phi$ LH	-0.3 to +18	V	
Voltage difference between P-well and vertical clock	VPW-V $\phi$ V	-28 to 0	V	1
Storage temperature	TSTG	-40 to +85	°C	
Ambient operating temperature	TOPR	-20 to +70	°C	

**NOTE :**

1. The OFD clock  $\phi$ OFD is excluded.

## RECOMMENDED OPERATING CONDITIONS

PARAMETER		SYMBOL	MIN.	TYP.	MAX.	UNIT	NOTE
Ambient operating temperature		TOPR		25.0		°C	
Output transistor drain voltage		V <sub>OD</sub>	14.5	15.0	16.0	V	
Overflow drain voltage	When DC is applied	V <sub>OFD</sub>	5.0		19.0	V	1
	When pulse is applied p-p level	V <sub>ΦOFD</sub>	21.5			V	2
Ground		GND		0.0		V	
P-well voltage		V <sub>PW</sub>	-10.0		V <sub>ΦVL</sub>	V	
Vertical shift register clock	LOW level	V <sub>ΦV1L</sub> , V <sub>ΦV2L</sub> V <sub>ΦV3L</sub> , V <sub>ΦV4L</sub>	-9.5	-9.0	-7.5	V	
	INTERMEDIATE level	V <sub>ΦV1I</sub> , V <sub>ΦV2I</sub> V <sub>ΦV3I</sub> , V <sub>ΦV4I</sub>		0.0		V	
	HIGH level	V <sub>ΦV1H</sub> , V <sub>ΦV3H</sub>	14.5	15.0	17.0	V	
Horizontal shift register clock	LOW level	V <sub>ΦH1L</sub> , V <sub>ΦH2L</sub>	-0.05	0.0	0.05	V	
	HIGH level	V <sub>ΦH1H</sub> , V <sub>ΦH2H</sub>	4.7	5.0	6.0	V	
Horizontal shift register final stage clock	LOW level	V <sub>ΦLH1L</sub>	-0.05	0.0	0.05	V	
	HIGH level	V <sub>ΦLH1H</sub>	4.7	5.0	6.0	V	
Reset gate clock	LOW level	V <sub>ΦRSL</sub>	0.0		V <sub>OD</sub> - 14.0	V	
	HIGH level	V <sub>ΦRSH</sub>	V <sub>OD</sub> - 9.5		10.0	V	
Vertical shift register clock frequency		f <sub>ΦV1</sub> , f <sub>ΦV2</sub> f <sub>ΦV3</sub> , f <sub>ΦV4</sub>		15.73		kHz	
Horizontal shift register clock frequency		f <sub>ΦH1</sub> , f <sub>ΦH2</sub> , f <sub>ΦLH1</sub>		14.32		MHz	
Reset gate clock frequency		f <sub>ΦRS</sub>		14.32		MHz	

## NOTES :

- Connect NC1 and NC2 to GND directly or through a capacitor larger than 0.047 μF.
1. When DC voltage is applied, shutter speed is 1/60-second.
  2. When pulse is applied, shutter speed is less than 1/60-second.

\* To apply power, first connect GND and then turn on V<sub>OFD</sub>. After turning on V<sub>OFD</sub>, turn on PW first and then turn on other powers and pulses. Do not connect the device to or disconnect it from the plug socket while power is being applied.

**CHARACTERISTICS FOR LZ2353B** (Drive method : Field accumulation)

(TA = +25 °C, Operating conditions : The typical values specified in "RECOMMENDED OPERATING CONDITIONS".

Color temperature of light source : 3 200 K, IR cut-off filter (CM-500, 1 mm) is used.)

PARAMETER	SYMBOL	MIN.	TYP.	MAX.	UNIT	NOTE
Standard output voltage	Vo		150		mV	2
Photo response non-uniformity	PRNU			10	%	3
Saturation output voltage	VSAT	700			mV	4
Dark output voltage	VDARK		0.5	3.0	mV	1, 5
Dark signal non-uniformity	DSNU		0.5	2.0	mV	1, 6
Sensitivity	R	260	350		mV	7
Smear ratio	SMR		-84	-76	dB	8
Image lag	AI			1.0	%	9
Blooming suppression ratio	ABL	1 000				10
Output transistor drain current	IOD		4.0	8.0	mA	
Output impedance	Ro		350		Ω	
Dark noise	VNOISE		0.2	0.3	mV	11
OB difference in level				1.0	mV	1, 12
Vector breakup				5.0	°, %	13
Line crawling				1.5	%	14
Luminance flicker				2.0	%	15

**NOTES :**

- VOFD should be adjusted to the minimum voltage such that ABL satisfy the specification, or to the value displayed on the device.
1. TA = +60 °C
  2. The average output voltage under uniform illumination. The standard exposure conditions are defined as when Vo is 150 mV.
  3. The image area is divided into 10 x 10 segments under the standard exposure conditions. Each segment's voltage is the average output voltage of all pixels within the segment. PRNU is defined by  $(V_{max} - V_{min})/V_o$ , where Vmax and Vmin are the maximum and minimum values of each segment's voltage respectively.
  4. The image area is divided into 10 x 10 segments. Each segment's voltage is the average output voltage of all pixels within the segment. VSAT is the minimum segment's voltage under 10 times exposure of the standard exposure conditions.
  5. The average output voltage under non-exposure conditions.
  6. The image area is divided into 10 x 10 segments under non-exposure conditions. DSNU is defined by  $(V_{dmax} - V_{dmin})$ , where Vdmax and Vdmin are the maximum and minimum values of each segment's voltage respectively.
  7. The average output voltage when a 1 000 lux light source with a 90% reflector is imaged by a lens of F4, f50 mm.
  8. The sensor is exposed only in the central area of V/10 square with a lens at F4, where V is the vertical image size. SMR is defined by the ratio of the output voltage detected during the vertical blanking period to the maximum output voltage in the V/10 square.
  9. The sensor is exposed at the exposure level corresponding to the standard conditions. AI is defined by the ratio of the output voltage measured at the 1st field during the non-exposure period to the standard output voltage.
  10. The sensor is exposed only in the central area of V/10 square, where V is the vertical image size. ABL is defined by the ratio of the exposure at the standard conditions to the exposure at a point where blooming is observed.
  11. The RMS value of the dark noise (after CDS). (100 kHz to 4.2 MHz, SC trap on.)
  12. The difference of the average output voltage between the effective area and the OB area under non-exposure conditions.
  13. Observed with a vector scope when the color bar chart is imaged under the standard exposure conditions.
  14. The difference between the average output voltage of the (Mg + Ye), (G + Cy) line and that of the (Mg + Cy), (G + Ye) line under the standard exposure conditions.
  15. The difference between the average output voltage of the odd field and that of the even field under the standard exposure conditions.

**CHARACTERISTICS FOR LZ2354BJ** (Drive method : Field accumulation)

(TA = +25 °C, Operating conditions : The typical values specified in "RECOMMENDED OPERATING CONDITIONS".

Color temperature of light source : 3 200 K, IR cut-off filter (CM-500, 1 mmt) is used.)

PARAMETER	SYMBOL	MIN.	TYP.	MAX.	UNIT	NOTE
Standard output voltage	Vo		150		mV	2
Photo response non-uniformity	PRNU			10	%	3
Saturation output voltage	VSAT	700			mV	4
Dark output voltage	VDARK		0.5	3.0	mV	1, 5
Dark signal non-uniformity	DSNU		0.5	2.0	mV	1, 6
Sensitivity	R	410	550		mV	7
Gamma	$\gamma$		1			
Smear ratio	SMR		-84	-76	dB	8
Image lag	AI			1.0	%	9
Blooming suppression ratio	ABL	1 000				10
Output transistor drain current	IOD		4.0	8.0	mA	
Output impedance	Ro		350		$\Omega$	
Dark noise	VNOISE		0.2	0.3	mV	11
OB difference in level				1.0	mV	1, 12

**NOTES :**

- VOFD should be adjusted to the minimum voltage such that ABL satisfy the specification, or to the value displayed on the device.
1. TA = +60 °C
  2. The average output voltage under uniform illumination. The standard exposure conditions are defined as when Vo is 150 mV.
  3. The image area is divided into 10 x 10 segments under the standard exposure conditions. Each segment's voltage is the average output voltage of all pixels within the segment. PRNU is defined by  $(V_{max} - V_{min})/V_o$ , where Vmax and Vmin are the maximum and minimum values of each segment's voltage respectively.
  4. The image area is divided into 10 x 10 segments. Each segment's voltage is the average output voltage of all pixels within the segment. VSAT is the minimum segment's voltage under 10 times exposure of the standard exposure conditions.
  5. The average output voltage under non-exposure conditions.
  6. The image area is divided into 10 x 10 segments under non-exposure conditions. DSNU is defined by  $(V_{dmax} - V_{dmin})$ , where Vdmax and Vdmin are the maximum and minimum values of each segment's voltage respectively.
  7. The average output voltage when a 1 000 lux light source with a 90% reflector is imaged by a lens of F4, f50 mm.
  8. The sensor is exposed only in the central area of V/10 square with a lens at F4, where V is the vertical image size. SMR is defined by the ratio of the output voltage detected during the vertical blanking period to the maximum output voltage in the V/10 square.
  9. The sensor is exposed at the exposure level corresponding to the standard conditions. AI is defined by the ratio of the output voltage measured at the 1st field during the non-exposure period to the standard output voltage.
  10. The sensor is exposed only in the central area of V/10 square, where V is the vertical image size. ABL is defined by the ratio of the exposure at the standard conditions to the exposure at a point where blooming is observed.
  11. The RMS value of the dark noise after CDS. (100 kHz to 4.2 MHz, SC trap on.)
  12. The difference between the average output voltage of the effective area and that of the OB area under non-exposure conditions.

PIXEL STRUCTURE

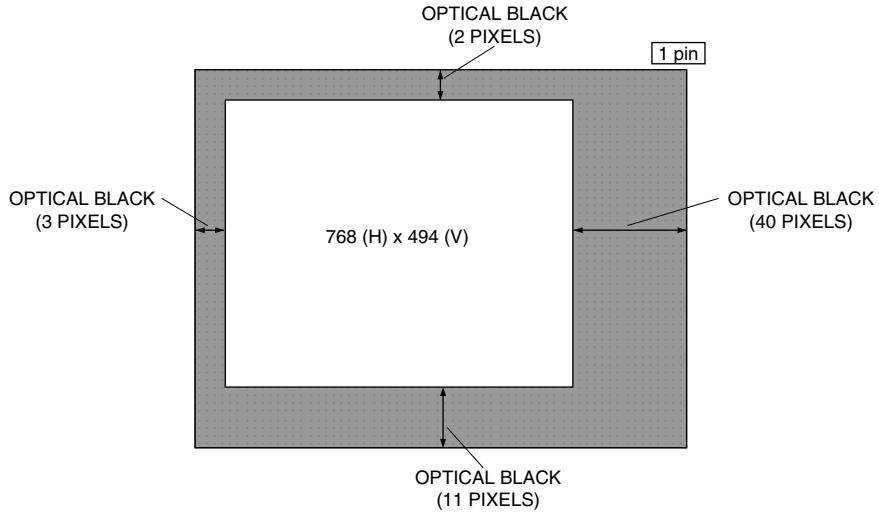

COLOR FILTER ARRAY (FOR LZ2353B)

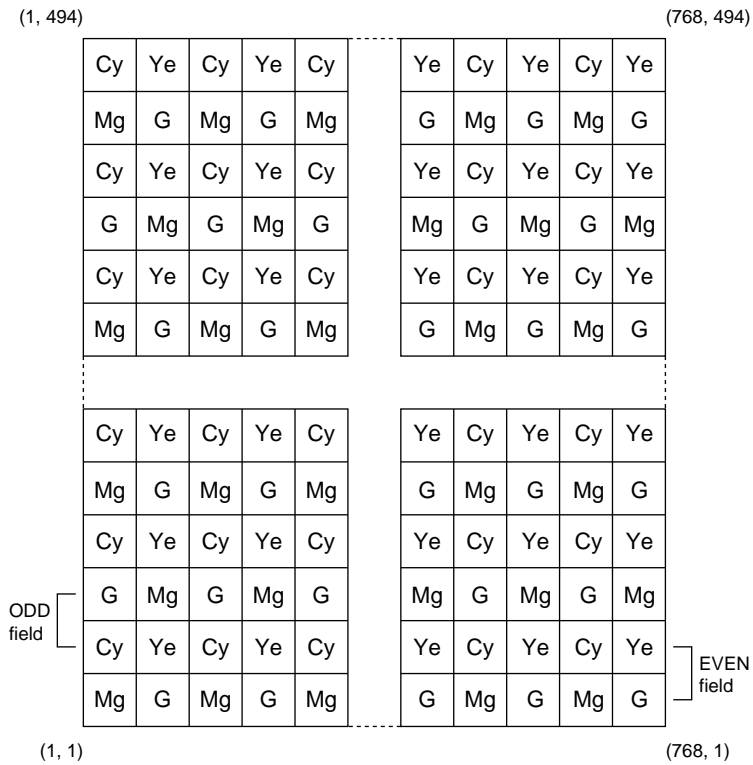



(ODD FIELD)

READOUT TIMING

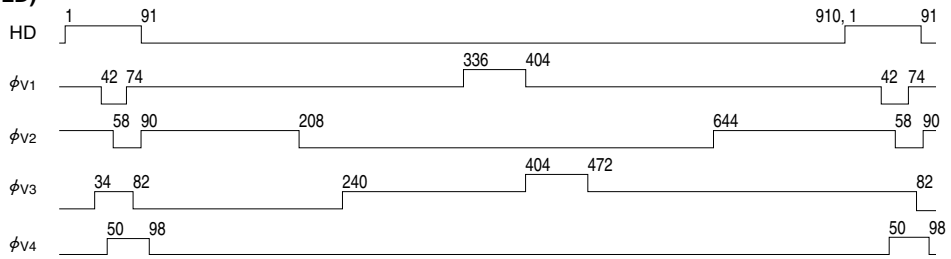

(EVEN FIELD)

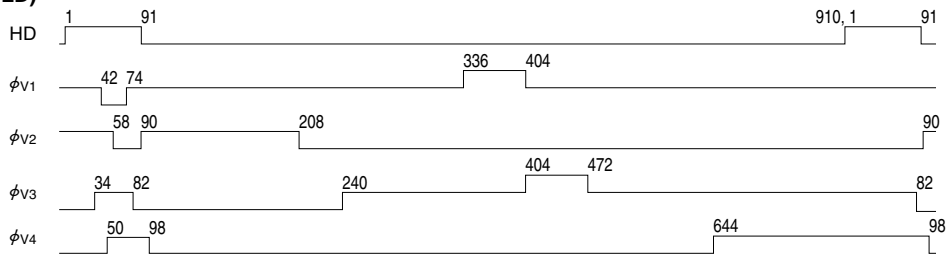



SYSTEM CONFIGURATION EXAMPLE

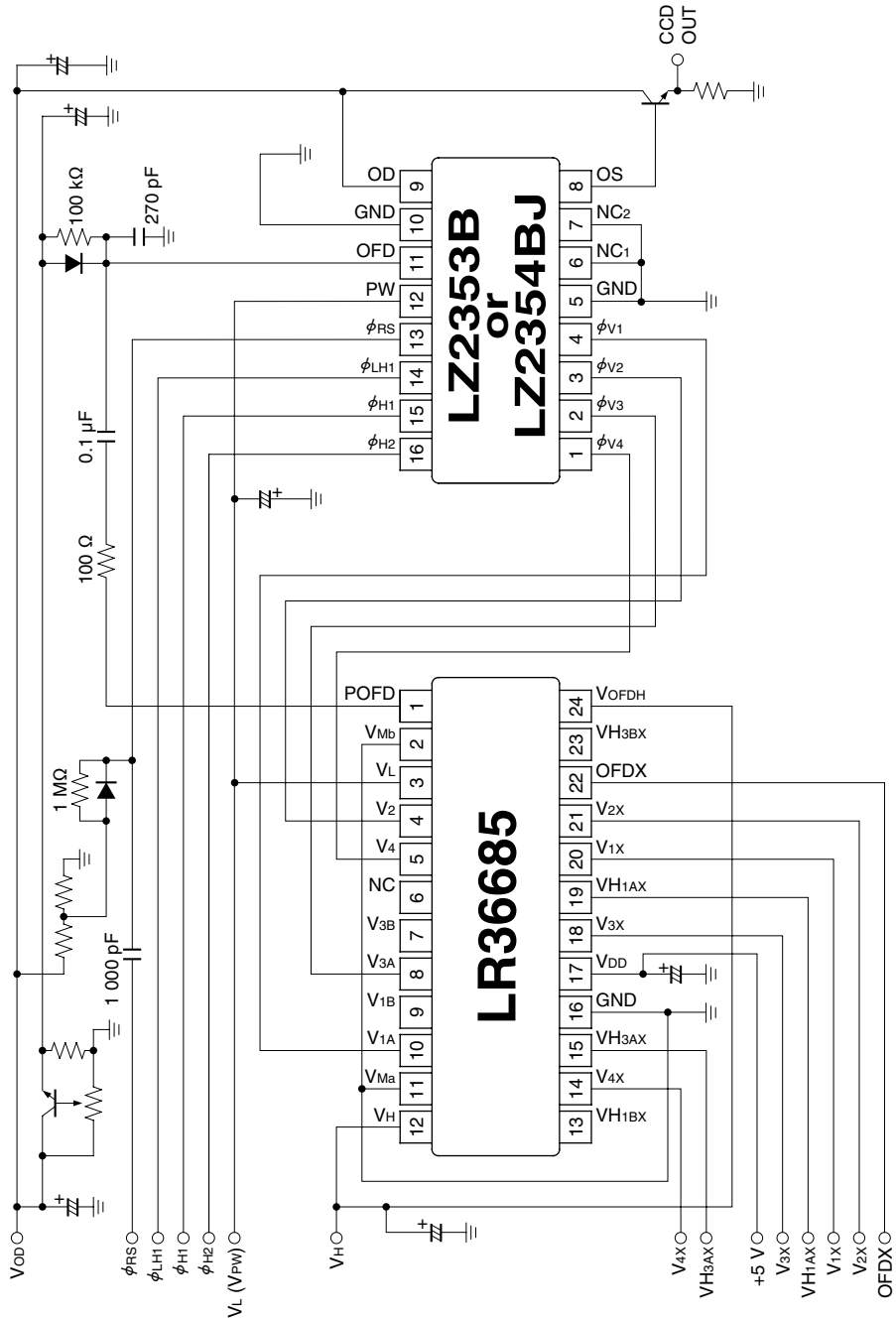

PACKAGE

(Unit : mm)

16 WDIP (WDIP016-N-0450)

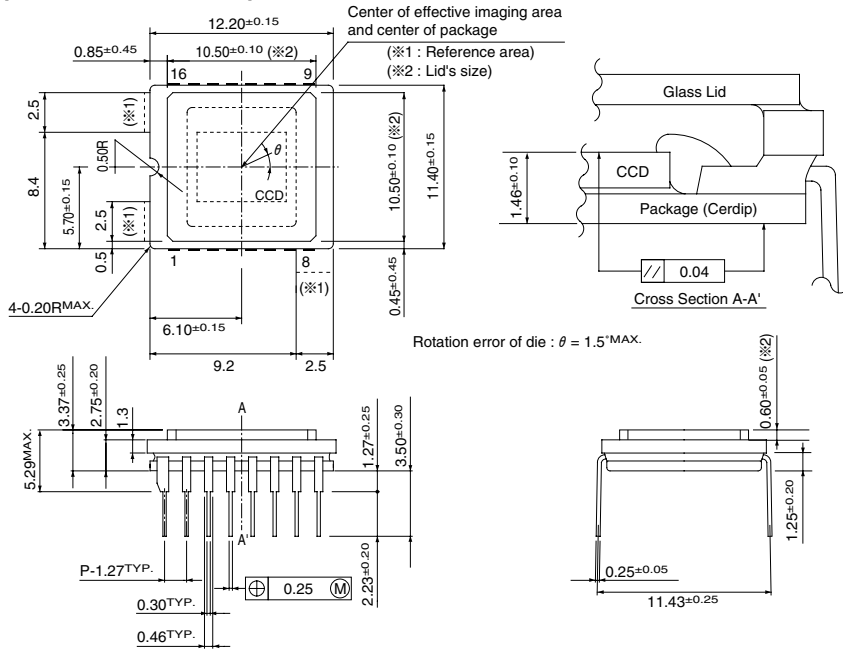

## PRECAUTIONS FOR CCD AREA SENSORS

### 1. Package Breakage

In order to prevent the package from being broken, observe the following instructions :

- 1) The CCD is a precise optical component and the package material is ceramic or plastic.

Therefore,

- Take care not to drop the device when mounting, handling, or transporting.
- Avoid giving a shock to the package.

Especially when leads are fixed to the socket or the circuit board, small shock could break the package more easily than when the package isn't fixed.

- 2) When applying force for mounting the device or any other purposes, fix the leads between a joint and a stand-off, so that no stress will be given to the jointed part of the lead. In addition, when applying force, do it at a point below the stand-off part.

(In the case of ceramic packages)

- The leads of the package are fixed with low melting point glass, so stress added to a lead could cause a crack in the low melting point glass in the jointed part of the lead.

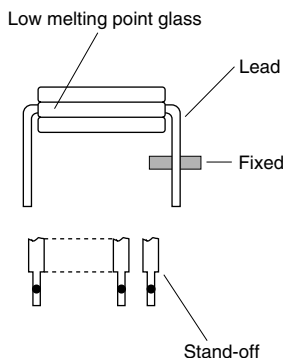

(In the case of plastic packages)

- The leads of the package are fixed with package body (plastic), so stress added to a lead could cause a crack in the package body (plastic) in the jointed part of the lead.

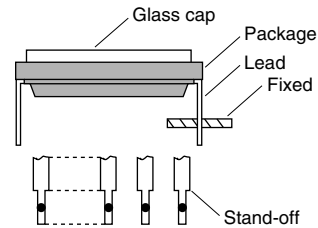

- 3) When mounting the package on the housing, be sure that the package is not bent.
  - If a bent package is forced into place between a hard plate or the like, the package may be broken.

- 4) If any damage or breakage occurs on the surface of the glass cap, its characteristics could deteriorate.

Therefore,

- Do not hit the glass cap.
- Do not give a shock large enough to cause distortion.
- Do not scrub or scratch the glass surface.
- Even a soft cloth or applicator, if dry, could cause dust to scratch the glass.

### 2. Electrostatic Damage

As compared with general MOS-LSI, CCD has lower ESD. Therefore, take the following anti-static measures when handling the CCD :

- 1) Always discharge static electricity by grounding the human body and the instrument to be used. To ground the human body, provide resistance of about 1 MΩ between the human body and the ground to be on the safe side.
- 2) When directly handling the device with the fingers, hold the part without leads and do not touch any lead.

- 3) To avoid generating static electricity,
  - a. do not scrub the glass surface with cloth or plastic.
  - b. do not attach any tape or labels.
  - c. do not clean the glass surface with dust-cleaning tape.
- 4) When storing or transporting the device, put it in a container of conductive material.

### **3. Dust and Contamination**

Dust or contamination on the glass surface could deteriorate the output characteristics or cause a scar. In order to minimize dust or contamination on the glass surface, take the following precautions :

- 1) Handle the CCD in a clean environment such as a cleaned booth. (The cleanliness level should be, if possible, class 1 000 at least.)
- 2) Do not touch the glass surface with the fingers. If dust or contamination gets on the glass surface, the following cleaning method is recommended :
  - Dust from static electricity should be blown off with an ionized air blower. For anti-electrostatic measures, however, ground all the leads on the device before blowing off the dust.

- The contamination on the glass surface should be wiped off with a clean applicator soaked in Isopropyl alcohol. Wipe slowly and gently in one direction only.
- Frequently replace the applicator and do not use the same applicator to clean more than one device.

※ Note : In most cases, dust and contamination are unavoidable, even before the device is first used. It is, therefore, recommended that the above procedures should be taken to wipe out dust and contamination before using the device.

### **4. Other**

- 1) Soldering should be manually performed within 5 seconds at 350 °C maximum at soldering iron.
- 2) Avoid using or storing the CCD at high temperature or high humidity as it is a precise optical component. Do not give a mechanical shock to the CCD.
- 3) Do not expose the device to strong light. For the color device, long exposure to strong light will fade the color of the color filters.